

PCR-272

Electronic Cash Register



User's Manual

START-UP is QUICK and EASY!

Simple to use!

20 departments and 120 PLUs

Automatic Tax Calculations

Calculator function



CASIO COMPUTER CO., LTD.

6-2, Hon-machi 1-chome

Shibuya-ku, Tokyo 151-8543, Japan

CASIO®

CI

Thank you very much for purchasing this CASIO electronic cash register. START-UP is QUICK and EASY!

Part-1 of this User's Manual can help you make a quick start.

Once you have mastered the QUICK START operations, you will undoubtedly want to expand your use of this machine by studying other sections of Part-2.

IMPORTANT

FOR PROGRAMMING ASSISTANCE
PLEASE CALL TOLL FREE

1-800-638-9228

CASIO Authorized Service Centers

If your CASIO product needs repair, or you wish to purchase replacement parts, please call 1-800-YO-CASIO.

Original Carton/Package

If for any reason, this product is to be returned to the store where purchased, it must be packed in the original carton/package.

Location

Locate the Cash register on a flat, stable surface, away from heaters or areas exposed to direct sunlight, humidity or dust.

Power Supply

Your cash register is designed to operate on standard household current (120 V, 50/60 Hz). Do not overload the outlet by plugging in too many appliances.

Cleaning

Clean the cash register exterior with a soft cloth which has been moistened with a solution of a mild neutral detergent and water, and wrung out. Be sure that the cloth is thoroughly wrung out to avoid damage to the printer.

Never use paint thinner, benzene, or other volatile solvents.

The mains plug on this equipment must be used to disconnect mains power. Please ensure that the socket outlet is installed near the equipment and shall be easily accessible.

Safety precautions

- To use this product safely and correctly, read this manual thoroughly and operate as instructed. After reading this guide, keep it close at hand for easy reference. Please keep all informations for future reference.
- Always observe the warnings and cautions indicated on the product.

About the icons

In this guide various icons are used to highlight safe operation of this product and to prevent injury to the operator and other personnel and also to prevent damage to property and this product. The icons and definitions are given below.



Indicates that there is a risk of severe injury or death if used incorrectly.



Indicates that injury or damage may result if used incorrectly.

Icon examples

To bring attention to risks and possible damage, the following types of icons are used.



The  symbol indicates that it includes some symbol for attracting attention (including warning). In this triangle the actual type of precautions to be taken (electric shock, in this case) is indicated.



The  symbol indicates a prohibited action. In this symbol the actual type of prohibited actions (disassembly, in this case) will be indicated.



The  symbol indicates a restriction. In this symbol the type of actual restriction (removal of the power plug from an outlet, in this case) is indicated.

Warning!

Handling the register



Should the register malfunction, start to emit smoke or a strange odor, or otherwise behave abnormally, immediately shut down the power and unplug the AC plug from the power outlet. Continued use creates the danger of fire and electric shock.

- Contact CASIO service representative.



Do not place containers of liquids near the register and do not allow any foreign matter to get into it. Should water or other foreign matter get into the register, immediately shut down the power and unplug the AC plug from the power outlet. Continued use creates the danger of short circuit, fire and electric shock.

- Contact CASIO service representative.



Should you drop the register and damage it, immediately shut down the power and unplug the AC plug from the power outlet. Continued use creates the danger of short circuit, fire and electric shock.

- Attempting to repair the register yourself is extremely dangerous. Contact CASIO service representative.



Never try to take the register apart or modify it in any way. High-voltage components inside the register create the danger of fire and electric shock.

- Contact CASIO service representative for all repair and maintenance.

Power plug and AC outlet



Use only a proper AC electric outlet. Use of an outlet with a different voltage from the rating creates the danger of malfunction, fire, and electric shock. Overloading an electric outlet creates the danger of overheating and fire.



Make sure the power plug is inserted as far as it will go. Loose plugs create the danger of electric shock, overheating, and fire.

- Do not use the register if the plug is damaged. Never connect to a power outlet that is loose.

INTRODUCTION

Warning!



Use a dry cloth to periodically wipe off any dust built up on the prongs of the plug. Humidity can cause poor insulation and create the danger of electric shock and fire if dust stays on the prongs.



Do not allow the power cord or plug to become damaged, and never try to modify them in any way. Continued use of a damaged power cord can cause deterioration of the insulation, exposure of internal wiring, and short circuit, which creates the danger of electric shock and fire.

- Contact CASIO service representative whenever the power cord or plug requires repair or maintenance.



Caution!

Do not place the register on an unstable or uneven surface. Doing so can cause the register — especially when the drawer is open — to fall, creating the danger of malfunction, fire, and electric shock.



Do not place the register in the following areas.

- Areas where the register will be subject to large amounts of humidity or dust, or directly exposed to hot or cold air.
- Areas exposed to direct sunlight, in a close motor vehicle, or any other area subject to very high temperatures.

The above conditions can cause malfunction, which creates the danger of fire.



Do not overlay bend the power cord, do not allow it to be caught between desks or other furniture, and never place heavy objects on top of the power cord. Doing so can cause short circuit or breaking of the power cord, creating the danger of fire and electric shock.



Be sure to grasp the plug when unplugging the power cord from the wall outlet. Pulling on the cord can damage it, break the wiring, or cause short, creating the danger of fire and electric shock.



Never touch the plug while your hands are wet. Doing so creates the danger of electric shock. Pulling on the cord can damage it, break the wiring, or cause short, creating the danger of fire and electric shock.



At least once a year, unplug the power plug and use a dry cloth or vacuum cleaner to clear dust from the area around the prongs of the power plug.

Never use detergent to clean the power cord, especially power plug.



Keep small parts out of the reach of small children to make sure it is not swallowed accidentally.

Contents

Getting to know your cash register	6
Daily Job Flow	8
Part-1 QUICK START OPERATION	9
(You can operate this ECR on a basic level by reading the following sections)	
1. Initialization	9
2. Loading Paper	10
3. Basic Programming for QUICK START – TIME/DATE	11
4. Basic Operation after Basic Programming.....	12
5. Daily Management Report.....	15
Part-2 CONVENIENT OPERATION.....	17
(Please keep these sections to expand your use.)	
1. Various Programming	17
2. Various Operations	27
Part-3 CALCULATOR FUNCTION	34
1. Calculator Mode.....	34
Part-4 USEFUL INFORMATION.....	36
1. Troubleshooting	36
2. Specifications.....	36
3. Warranty Card	45

Basic Components and Accessories

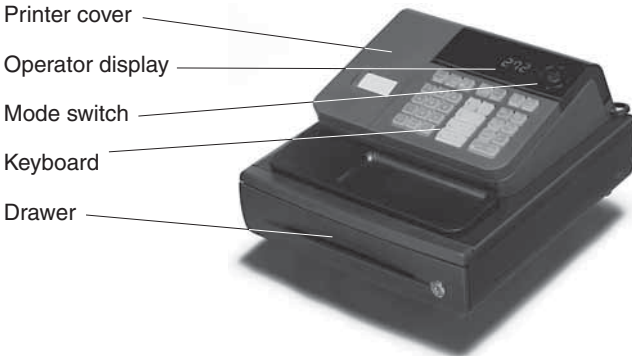

Accessories	
Roll paper	1 pc
Mode keys	OP key 1 pc
	PGM key 1 pc
Drawer keys	2 pcs
User's manual	1 pc
Magnetic plate*	1 pc

* Use this plate for tacking the notes received from customer.

Weld lines

Lines may be visible on the exterior of the product. These are “weld lines” that result from the plastic molding process. They are not cracks or scratches.

Getting to know your cash register

Mode Switch

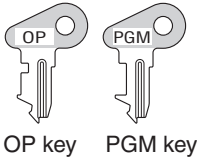
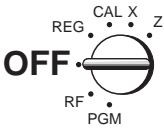

The position of the Mode Switch controls the type of operations you can perform on the cash register. The PROGRAM key (marked PGM) can select any Mode Switch setting, while OPERATOR key (marked OP) can be used to select OFF, REG or CAL only.

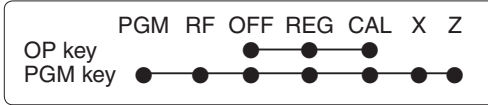

OFF

In this position, the power of the cash register is off.

REG (Register)

This is the position used for registration of normal transactions.

RF (Refund)

This is the position used for registration of refunds.

CAL (Calculator)

This is the position used for calculator mode.

PGM (Programming)

This is the position used to program the cash register to suit the needs of your store.

X (Read)

This is the position used to produce reports of daily sales totals without clearing the totals.

Z (Reset)

This is the position used to produce reports of daily sales totals. This setting clears the totals.

Note:

An error is generated (E01 displayed) whenever the position of the Mode Switch is changed during registration.

Display

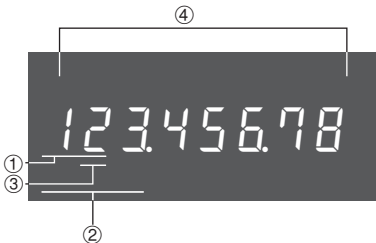

① Department Number Display

Anytime you press a department key to register a unit price, the corresponding department number appears here.

② PLU Number Display

Anytime you perform a PLU registration, the corresponding PLU number appears here.

③ Number of Repeat Display

Anytime you perform "repeat registration" (page 12), the number of repeats appears here.

Note that only one digit is displayed for the number of repeats.

④ Numeric Display

Entered values (unit prices or quantities) and calculated values (subtotals, totals or change amount due) are displayed here. The capacity of the display is 8 digits.

This part of the display can be used to show the current time or date between registration (page 31).

Keyboard

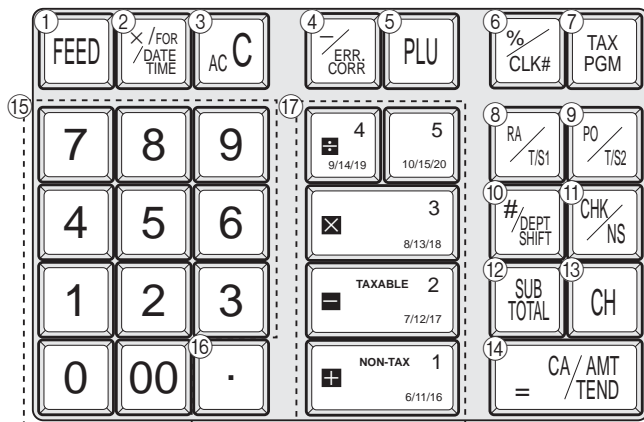

Certain keys have two functions; one for register mode and one for calculator mode. In this manual, we will refer to specific keys as noted below to make the operations as easy to understand as possible:

Register Mode

- ① FEED Feed key
- ② X/ FOR DATE TIME Multiplication/Split pricing/Date Time key
- ③ AC C Clear key
- ④ -/ ERR CORR Minus/Error Correction key
- ⑤ PLU PLU (Price Look Up) key
- ⑥ %/ CLK# Percent/Cashier ID No. Assignment key
- ⑦ TAX PGM Tax Program key
- ⑧ RA / T/S1 Received on Account/Tax Status Shift 1 key
- ⑨ PO / T/S2 Paid Out/Tax Status Shift 2 key
- ⑩ #/ DEPT SHIFT Reference Number/Department Shift key
- ⑪ CHK / NS Check/No Sale key
- ⑫ SUB TOTAL Subtotal key
- ⑬ CH Charge key
- ⑭ = CA / AMT TEND Cash Amount Tendered key
- ⑮ 0, 1, ~ 9, 00 Numeric keys and 2-zero key
- ⑯ . Decimal key
- ⑰ + 1, - 2, x 3, ÷ 4, 5 Department keys

- Department 6 through 20 are specified by pressing the key respectively as follows:

- + 1 ~ 5 → Department 6 ~ 10
- + 1 ~ 5 → Department 11 ~ 15
- + 1 ~ 5 → Department 16 ~ 20

Calculator Mode

- ③ AC C AC key
- ⑤ PLU Memory Recall key
- ⑥ %/ CLK# Percent key
- ⑪ CHK / NS Drawer Open key
- ⑭ = CA / AMT TEND Equal key
- ⑮ 0, 1, ~ 9, 00 Numeric keys and 2-zero key
- ⑯ . Decimal key
- ⑰ + 1, - 2, x 3, ÷ 4 Arithmetic Operation key

Daily Job Flow



Before Opening The Store

1. Plugged in? Page-10
2. Enough Roll Paper? Page-31
3. Date and Time is correct? Page-31
4. Enough small change in the drawer? Page-32

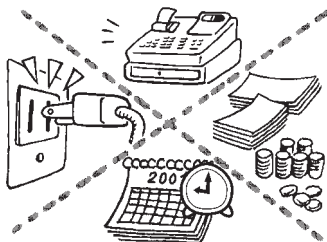

While The Store Is Open

1. Registrations. Page-12~
2. Issuing latest daily sales total if needed. (Generating report by Mode Switch to X position.) Page-15



After Closing The Store

1. Issuing Daily Sales Total. (Resetting report by Mode Switch to Z position.) Page-15
2. Picking up money in the drawer. Page-32
3. Turn the Mode Switch to OFF.



Other

1. Troubleshooting Page-36

When the cash drawer does not open!

In case of power failure or the machine is in malfunction, the cash drawer does not open automatically. Even in these cases, you can open the cash drawer by pulling drawer release lever (see below).

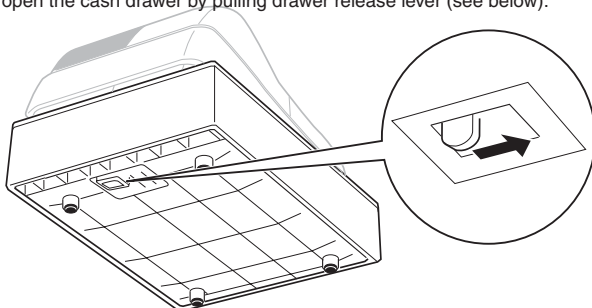

Important!

The drawer will not open, if it is locked with a drawer lock key.

1. Initialization and Loading Memory Protection Battery

Important

You must initialize the Cash register and install the memory protection batteries before you can program the cash register.

▶ To initialize the cash register

1. Set the Mode Switch to OFF.
2. Load the memory protection batteries.
3. Plug the power cord of the cash register into an AC outlet.
4. Set the Mode Switch to REG.

▶ To load the memory protection batteries

1. Remove the printer cover.
2. Open the battery compartment cover.
3. Load 3 new SUM-3 ("AA") type batteries into the compartment. Be sure that the plus (+) and minus (-) ends of each battery are facing in the directions indicated by the illustrations inside the battery compartment (Figure 1).
4. Replace the memory protection battery compartment cover back into place.
5. Replace the printer paper and printer cover.



(Figure 1)

REPLACE MEMORY PROTECTION BATTERIES AT LEAST ONCE EVERY YEAR.

2. Loading Paper Roll And Replacing The Printer's Ink Roll

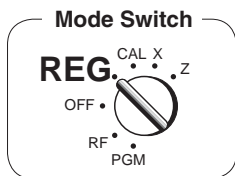

1. To load journal paper

- ① Remove the printer cover by lifting up the back.



- ② Put a roll of journal paper into the holder.
- ③ Cut the leading end of the roll paper with scissors and insert the paper into the inlet.



- ④ Press the **FEED** key until 20 or 30 cm of paper is fed from the printer.
- ⑤ Roll the paper onto the take-up reel a few turns.



- ⑥ Set the left plate of the take-up reel and place the reel into the register.



- ⑦ Press the **FEED** key to take up any slack in the paper.
- ⑧ Replace the printer cover by placing the cover's front tab into the register's groove.



- ⑧ Load new paper following the instructions above, and replace the printer cover.

2. To remove journal paper

- ① Remove the printer cover following the instructions above.
- ② Press the **FEED** key until approximately 20cm of the paper is fed from the printer.
- ③ Cut off the roll paper.



- ④ Remove the take-up reel from the printer and take off the left plate of the reel.
- ⑤ Remove the journal paper from the take-up reel.



- ⑥ Cut off the paper left in the printer and press the **FEED** key until the remaining paper is fed out from the printer.



- ⑦ Remove the core of the paper.

Default printer setting is for Journal. To print receipts, please refer to 1-7-3 on page 22 to switch the printer for Receipt or Journal.

▶ To load receipt paper



- ① To use the printer to print receipts, follow steps 1 through 4 of "To load journal paper".
- ② Pass the leading end of the receipt paper through the printer cover's paper outlet and replace the printer cover.
- ③ Tear off any excess paper.

Options: Roll paper – P-5860
Ink Roll – IR-40

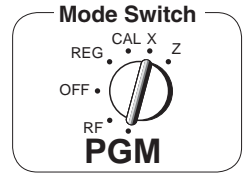
3. Basic Programming for QUICK START

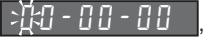

Part-1

Procedure	Purpose
1. Turn the mode switch to PGM position.	Programming
2. When the display shows blinking "0", such as  , enter current date in Month, Day, Year order. Example: January 8, 2010: enter 0 1 0 8 1 0 • Enter 6-digit, last 2 digits for year set. (2010 → 10) • By pressing AC/C , this procedure returns one by one.	Setting the current date
3. When the display shows blinking "0", such as  , enter current time in Hour, Minute order. Example: 1:18 PM, enter 1 3 1 8 • Enter 4-digit, use 24-hour system. • By pressing AC/C , this procedure returns one by one. • If you want to adjust the date/ time, please refer to page 31 of this manual.	Setting the current time
4. Input the desired flat tax rate to the appropriate department key. (This procedure below programs flat tax rate only. If your tax table has break points, refer to page 24 of this manual.) A) Press the TAX PGM key. B) Enter tax rate. (Example: For 6% enter "6", 5.75% enter "5.75".) C) Press the appropriate department key. D) Repeat step B) and C) to set other department key. E) Press the SUB TOTAL key to end tax programming. Note: In case of setting the wrong tax rate to the key, please enter 0 and press those department keys above, and quit this procedure by pressing SUB TOTAL key, and start from the beginning of this procedure. Please start with the department 2 key (taxable department). Department 1 key is initialized as non taxable. Example 1: Set state tax 4% to department 2, 3 key. TAX PGM Start tax program. 4 -2 Enter tax rate and press dept key. 4 × 3 Enter tax rate and press dept key. SUB TOTAL To end the setting. Example 2: Set state tax 5% to department 2 and 7% to department 3 key. TAX PGM Start tax program. 5 -2 Enter tax rate and press dept key. 7 × 3 Enter tax rate and press dept key. SUB TOTAL To end the setting.	Setting the tax rates

FOR PROGRAMMING ASSISTANCE, PLEASE CALL TOLL FREE 1-800-638-9228

4. Basic Operation after Basic Programming

Note:

Whenever an error is generated, the input figures reset to 0. All printout samples are journal images and the header (date, time and consecutive no.) are eliminated from the samples.

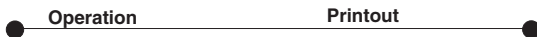
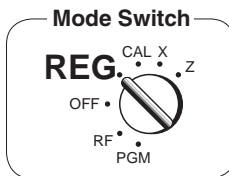

4-1 Open the drawer without a sale



..... NS

No Sales Symbol

4-2 Basic operation

Example

Unit Price	\$1.00	\$2.00	\$0.30
Quantity	1	1	1
Dept.	2	10	15
Cash Amount tendered	\$5.00		

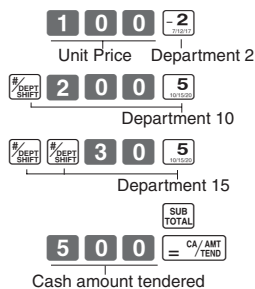

```

02  • 1•00 TX 1  Department No./Unit Price
10  • 2•00
15  • 0•30
      • 1•00 TA Taxable Subtotal
      • 0•04 TX 1 Tax
      • 3•34 ST Subtotal
      • 5•00 CA Cash Amount Tendered
      • 1•66 CG Change Amount Due
    
```

Departments 6 through 10, 11 through 15, 16 through 20 can also be registered in combination with the $\frac{\%}{\text{SHIFT}}$ and $\frac{\%}{\text{SHIFT}}$ [1], [-2], [x3], [x4] or [5] keys, respectively. The $\frac{\%}{\text{SHIFT}}$ key should be entered just before entering unit price manually.

4-3 Multiple registration on the same items

Example

Unit Price	\$1.00	\$1.35
Quantity	2	3
Dept.	2	2

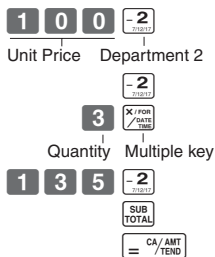

```

02  • 1•00 TX 1
02  • 1•00 TX 1  Repeat
      3 X Sales Quantity
      • 1•35 @ Unit Price
02  • 4•05 TX 1
      • 6•05 TA
      • 0•24 TX 1
      • 6•29 CA
    
```

Note that repeated registration can be used with unit prices up to 6 digits long.

4-4 Split sales of packaged items

Example

Unit Price	12\$10.00
Quantity	3
Dept.	2

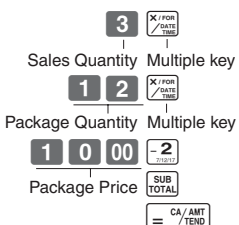

```

      3 X Sales Quantity
      12 Package Quantity
02  • 10•00 @ Unit Price
      • 2•50 TX 1
      • 2•50 TA
      • 0•10 TX 1
      • 2•60 CA
    
```

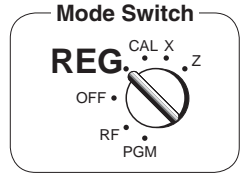

4-5 Charge sales

Example

Unit Price	\$1.00	\$2.00	\$3.00
Quantity	1	1	1
Dept.	1	2	1

Operation

1 0 0 [+1] CH
 2 0 0 [-2] CH
 3 0 0 [+1] CH
 SUB TOTAL
 CH

Charge key

Printout

01	•1•00	
02	•2•00	TX 1
01	•3•00	
	•2•00	TA
	•0•08	TX 1
	•6•08	CH

Charge Sales

You cannot perform the amount tendered operation using the **CH** key.

4-6 Split cash/charge sales

Example

Unit Price	\$2.00	\$3.00	\$4.00
Quantity	1	1	1
Dept.	1	2	1
Cash Amount tendered	\$5.00		

Operation

2 0 0 [+1] CH
 3 0 0 [-2] CH
 4 0 0 [+1] CH
 SUB TOTAL
 5 0 0 [=] CA/AMT TEND
 CH

Printout

01	•2•00	
02	•3•00	TX 1
01	•4•00	
	•3•00	TA
	•0•12	TX 1
	•9•12	ST
	•5•00	CA
	•4•12	CH

Cash Amount Tendered
Charge Sales

4-7 Corrections

Corrections can be made while you are registering the item (before you press a department key), or after it has already been registered into the memory (by pressing a department key).

4-7-1 Before you press a department key

AC C key clears the last item entered.

Example

- Entered 400 for unit price by mistake instead of 100.

Operation

4 0 0 **AC C**
 1 0 0 [+1] CH

Wrong entry Clears the last item entered.

Correct entry Registered Department 1

Printout

01	•1•00
----	-------

Part-1 QUICK START OPERATION

2. Entered unit price first instead of quantity and then pressed .

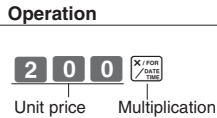

Clears the last item entered.

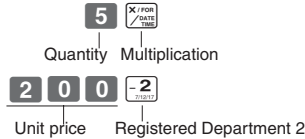

Printout

	5	X
	•2•00	@
02	•10•00	TX 1

3. Entered 150 for unit price by mistake instead of 105.

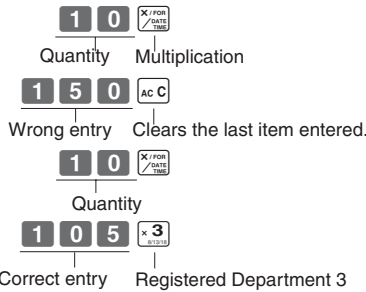

	10	X
	•1•05	@
03	•10•50	

4-7-2 After you pressed a department key

 key cancels the last registered item.

Example

1. Entered unit price 550 by mistake instead of 505 and pressed a department key.

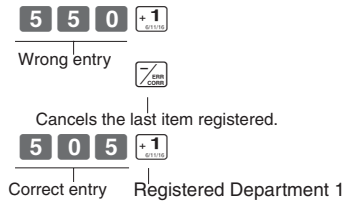

01	•5•50	
	-5•50	VD
01	•5•05	

2. Entered unit price 220 by mistake instead of 230 and pressed a department key.

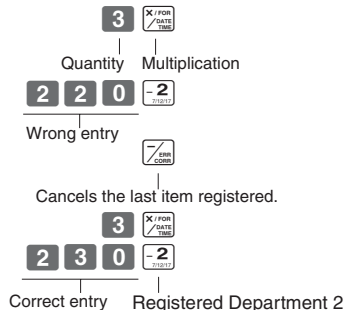

	3	X
	•2•20	@
02	•6•60	TX 1
	-6•60	VD
	3	X
	•2•30	@
02	•6•90	TX 1

5. Daily Management Report

This section tells you the procedures to use to produce reports of the transaction data stored in the cash register's memory.

Important

Remember that when you issue a reset (Z) report, the data that is reported is cleared from the applicable totalizers. To view data without clearing totalizers, issue a read (X) report.

Part-1

5-1 Financial Report

Operation

Printout

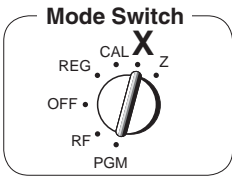

01-08-10	Date
14-27 0072	Time/Consecutive No.
X	Read Symbol
67 *	Gross Sales No. of Items
•270•48 *	Gross Sales Amount
38 NT	Net Sales No. of Customers
•271•24 NT	Net Sales Amount
•197•57 CA#	Cash Total in Drawer
•18•19 CH#	Charge Total in Drawer
•45•18 *CK	Check Total in Drawer

5-2 General Control Read/Reset Report

Operation

Printout

5-2-1 Daily Read/Reset Report

Mode Switch to **(X)** (Read)

Mode Switch to **(Z)** (Reset)

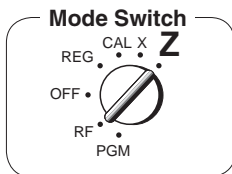

Z (Reset) report

01-08-10	Date
19-35 0073 1	Time/Consecutive No./Clerk No.
0001 Z	Non-resettable Sales No. of Resets ¹ /RESET Symbol ¹
01 48	No. of Items/Dept. No.
•50•10	Amount
02 28	
•76•40	
03 17	
•85•80	
04 4	
•76•00	
05 1	
•6•50	
06 1	
1•00	
19 2	
•1•00	
20 5	
•10•00	
108 *	Gross Sales No. of Items
•316•80 *	Gross Sales Amount

Part-1 QUICK START OPERATION

•0•50	-	Reduction Amount
•0•66	%-	Premium/Discount Amount
•105•10	TA	Taxable Amount 1
•4•20	TX 1	Tax Amount 1
•75•60	*TA	Taxable Amount 2
•3•97	TX2	Tax Amount 2
46	NT	Net Sales No. of Customers
•325•13	NT	Net Sales Amount
•325•13	1	Clerk 1 Sales Amount
(Refer to 2-10 Cashier Assignment)		
44	CA	Cash Sales Count
•203•91	CA	Cash Sales Amount
3	CH	Charge Sales Count
•16•22	CH	Charge Sales Amount
2	CK	Check Sales Count
•105•00	CK	Check Sales Amount
•6•00	RA	Received on Account Amount
•10•00	PO	Paid Out Amount
3	VO	Error Correction Count
1	RF	RF Mode Count
•3•00	RF	RF Mode Amount
5	CA X	No. of $\left[\begin{smallmatrix} CA \\ AMT \\ TEND \end{smallmatrix} \right]$ key operation in CAL mode
1	NS	No-sales Count
•199•91	CA#	Cash in Drawer
•16•22	CH#	Charge in Drawer
•105•00	*CK	Check in Drawer
000000		Non-resettable Grand Sales Total (printed only on RESET report)* ²
0325•13		

* X (Read) report is the same except ¹ and ².

5-2-2 Periodic Read/Reset Report

Operation

Printout

Mode Switch to **Z** or **X**

1 0 $\left[\begin{smallmatrix} CA \\ AMT \\ TEND \end{smallmatrix} \right]$

01-08-10		Date
19-50 0074		Time/Consecutive No.
10 ••••	X	Periodic
	X	Read Symbol
67 *		Gross Sales No. of Items
•270•73 *		Gross Sales Amount
38 NT		Net Sales No. of Customers
•271•24 NT		Net Sales Amount

Part 2

CONVENIENT OPERATION

1. Various Programming

1-1 Unit price for Departments

Example

Unit Price	\$1.00	\$2.20	\$11.00
Dept.	1	2	3

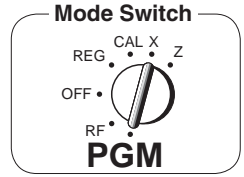
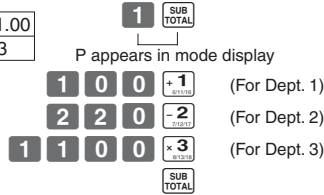

• Unit prices within the range of 0.01 ~ 9999.99.

1-2 Rate for percent key

Example

Discount Rate	2.5%
---------------	------

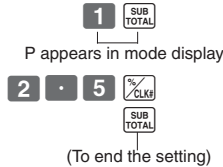

• The rate within the range of 00.01 to 99.99%.

1-3 To change tax status for Departments

Tax status for the Departments are fixed as follows:
 Department 2: Taxable status 1.
 Departments 1, 3~20: Non-Taxable status.

Example

Status	Non-Taxable	Taxable
Dept.	1 ~ 5	6 ~ 10

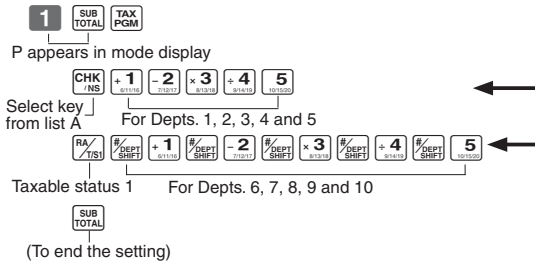

Selections	
Taxable status 1	RA/Tax
Taxable status 2	PO/Tax
Taxable status 1 and 2	RA/Tax PO/Tax
Taxable status 3	CH
Taxable status 1, 2 and 3	RA/Tax PO/Tax CH
Taxable status 4	X/ron
Non-taxable status	CHK/NS

A

1-4 Status for Department

Example

Depts.	Selections		
	A	B	C
1	0	4	1
2	0	5	1

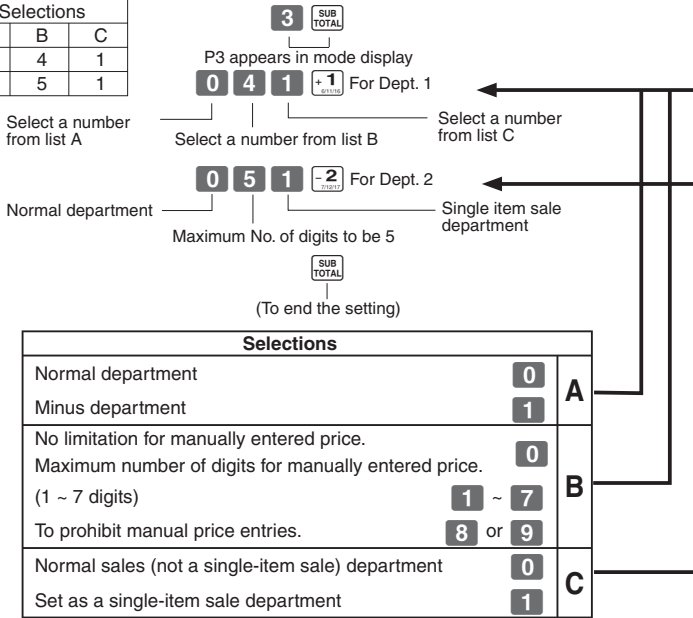

1-5 Status for percent key

1-5-1 To change taxable status for the percent key

Taxable status 1 is fixed for the percent key.

Example
Change Percent key registration as a Non-taxable.

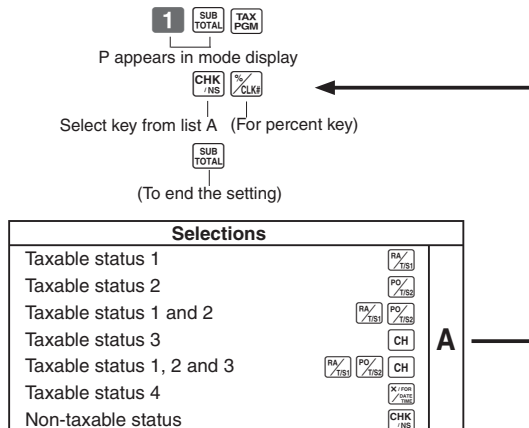

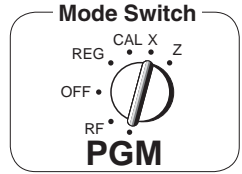

1-5-2 Status for percent key

Example

Round	Up
Percent	%+

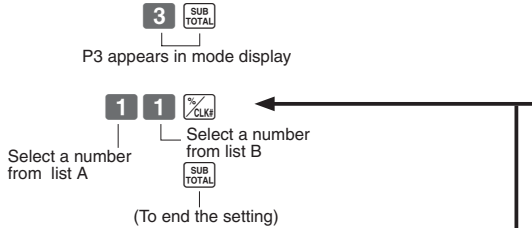

Selections	
Rounding of results produced by Percent Key operation.	
Round off (1.544=1.54; 1.545=1.55)	0
Round up (1.544=1.55; 1.545=1.55)	1
Cut off (1.544=1.54; 1.545=1.54)	2
Program Percent Key to register discounts (%-).	
Program Percent Key to register premiums (%+).	0
Program Percent Key to function as a Manual Tax key.	1
	2

Part-2

1-6 Taxable Status for minus key

Non-taxable status is fixed for the minus key.

Example

Change minus key registrations
Non-taxable status.

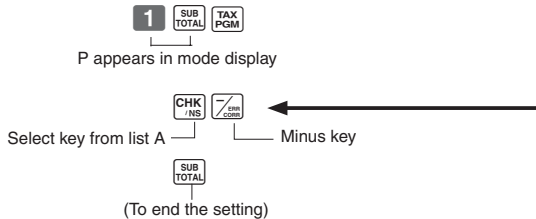

Selections	
Taxable status 1	RA / 1783
Taxable status 2	PO / 1783
Taxable status 1 and 2	RA / 1783 PO / 1783
Taxable status 3	CH
Taxable status 1, 2 and 3	RA / 1783 PO / 1783 CH
Taxable status 4	X min / 1783
Non-taxable status	CHK / INS

1-7 General features

1-7-1 To set general controls

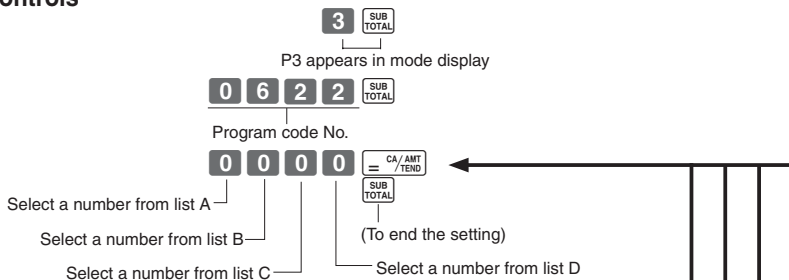

Selections	
Time display format: HH-MM	0 A
Time display format: HH-MM SS	4

Selections				
Maintain key buffer during receipt issue in REG mode.				
Reset the transaction number to zero whenever a General Control Reset Report is issued.				
Allow credit balance registration.				
No	Yes	Yes	0	B
	No	Yes	1	
Yes		Yes	2	
	Yes	No	3	
Yes		Yes	4	
	Yes	No	5	
No		Yes	6	
	No	No	7	

Selections			
Allow partial cash amount tendered.			
Allow partial check amount tendered.			
Yes	Yes	0	C
	No	2	
No	Yes	4	
	No	6	

Selections			
Use the 00 key as a 000 key.			
Cashier assignment systems (sign on) is used.			
No	No	0	D
	Yes	1	
Yes	No	2	
	Yes	3	

1-7-2 To set printing controls

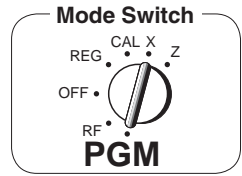
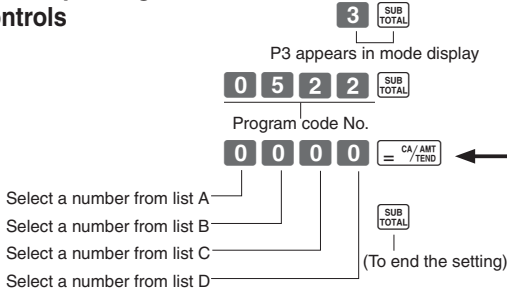

Selections	
Use the printer to print a journal.	0
Use the printer to print receipts.	1

Selections	
Print zero-total line on the General Control Read/Reset Reports	0
Do not print zero-total line on the General Control Read/Reset Reports.	1

Selections			
Print RF switch mode refund count/ amount on the General Control Read/Reset Reports.			
Print the grand sales total on the General Control Reset Reports.			
Print the time on the receipt and journal.			
Yes	No	Yes	0
	Yes	No	1
		Yes	2
	No	No	3
No	No	Yes	4
		No	5
	Yes	Yes	6
		No	7

Selections			
Print the consecutive number on the receipt/journal.			
Print the subtotal on the receipt/ journal when the Subtotal Key is pressed.			
Skip item print on journal.			
No	No	Yes	0
		No	1
	Yes	Yes	2
		No	3
Yes	No	Yes	4
		No	5
	Yes	Yes	6
		No	7

Part-2

Part-2 CONVENIENT OPERATION

1-7-3 Printer switch for Receipt or Journal

The printer is fixed as journal after initialized operation.

Example
To print a receipt.

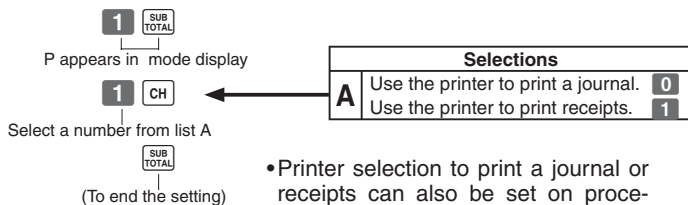

- Printer selection to print a journal or receipts can also be set on procedures 1-7-2 "To set printing controls".

1-8 PLU setting

1-8-1 Linkage with Departments

Example

PLU No.	1	100
Link Dept. No	1	10

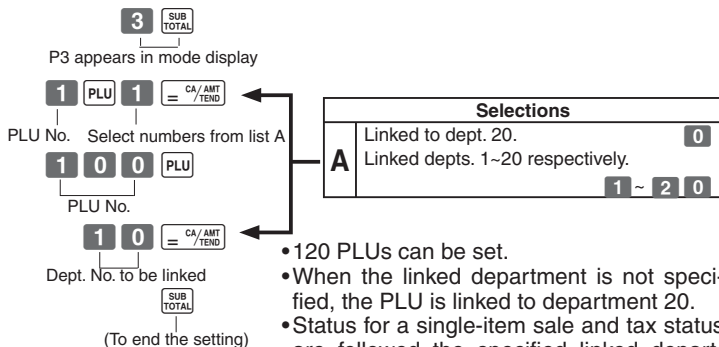

- 120 PLUs can be set.
- When the linked department is not specified, the PLU is linked to department 20.
- Status for a single-item sale and tax status are followed the specified linked department.

1-8-2 Unit Prices for PLUs

Example

PLU No.	1	2
Unit Price	\$1.00	\$3.00

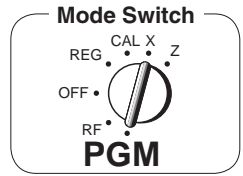
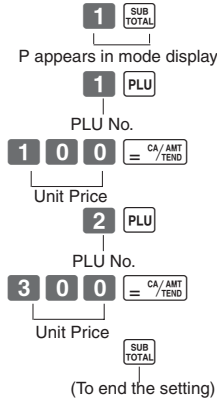

•Unit prices within the range of \$0.01~999.99.

1-9 To control Tax Status printing

Example

Print taxable amount and tax amount for Add-in.

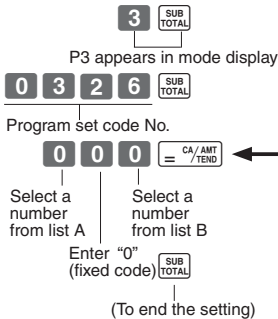

Selections	
Print Tax status symbols.	0
Do not print Tax status symbols.	2

Selections	
Print taxable amount.	
Print taxable amount and tax amount for Add-in.	
Yes	0
No	1
No	2
No	3

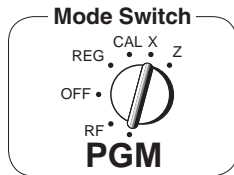

1-10 To program Tax Table

If your tax table is not a flat table (includes break points), find the tax table for your state on pages 37 through 44 of this manual. Follow the procedures below to set the tax tables.

Example 1: Set Alabama state tax 4%.

3		P3 appears in mode display
0 1 2 5		Program set code No. for tax table 1
0		1st code for 4%
1		
1		
1 0		
3 0		
5 4		
7 3		
1 1 0		Last code for 4%
		(to end the setting)

ALABAMA			
4%	5%	6%	6%
0	0	0	0
1	1	1	1
1	1	1	1
10	10	8	9
30	29	24	20
54	49	41	40
73	69	58	55
110	89		70
	110		90
			109

Note: If your table has break points, set it to this table (tax table 1).

Example 2: Set Colorado state tax 5.25%.

3		P3 appears in mode display
0 2 2 5		Program set code No. for Tax table 2
5 . 2 5		5.25% tax
5 0 0 2		50 for Round off and 02 for Add On
		(to end the setting)

COLORADO	
5.25%	
5.25	
5002	

- This sample programming can set only tax rate, but not for a tax break point.
- You can set tax table 3 and 4 by the set code No. 0325 (for table 3) and 0425 (for table 4)

Tax status for the Departments and function keys are fixed as follows:

- Department 2: Taxable status 1.
- Departments 1, 3-20: Non-Taxable status.
- Percent key: Taxable status 1.
- Minus key: Non-Taxable status.

- See page 17 (department key), 18 (percent key), 19 (minus key) to change the fixed tax status.

1-11 Printing to read All Preset Data

1-11-1 Printing preset data except PLU settings

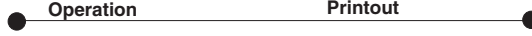
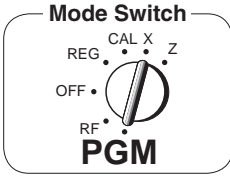

CA/AMT
= /TEND

01-08-10	Date
14-24 0070	Time/Consecutive No.
X	Read Symbol
01.....1.00	Dept. No./Unit Price
01-041	Tax Status/Normal Dept./Digit Limit/Single Item
02.....2.20	
02-051	
03.....11.00	
03-041	
20.....0.00	
00-000	
-----03	Minus/Tax Status
2.5 %	Percent Rate/%+ or %-
03-11	Tax Status/Percent Key Control
0122.....12	Date/Add Mode Control (fixed)
0222.....0000	Print Control
0522.....0022	General Control
0622.....0000	Calculation Control
1022.....0	Tax Control
0326.....0002	Tax Table 1
0125.....	
0.0000 %	
0001	
0001	
10	
30	
54	
73	Break Points Control
110	
0225.....	Tax Table 2
5.2500 %	
5002	Rounding Specifications/
0000	Tax System Specifications
01-08-10	

Part-2

Tax Status

Printout	Meaning	Printout	Meaning	Printout	Meaning
00	Non taxable	06	Taxable 1 & 3	12	Taxable 1, 2 & 4
01	Taxable 1	07	Taxable 1 & 4	13	Taxable 1, 3 & 4
02	Taxable 2	08	Taxable 2 & 3	14	Taxable 2, 3 & 4
03	Taxable 3	09	Taxable 2 & 4	15	All taxable
04	Taxable 4	10	Taxable 3 & 4		
05	Taxable 1 & 2	11	Taxable 1, 2 & 3		

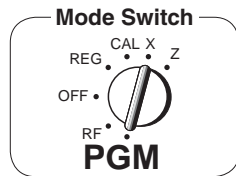

1-11-2 Printing pre-set PLU settings



1 CA/AMT /TEND

01-08-10	Date
14-26 0073	Time/Consecutive No.
X	Read symbol
001•••1•00	PLU No./Unit Price
01	Linked department
002•••2•00	
02	
003•••3•00	
03	
004•••4•00	
099•••••	
19	
100••10•00	
20	
01-08-10	

2. Various Operations

2-1 Registration using preset price for Departments.

(Programming: See page 17)

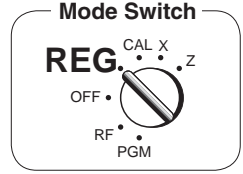

Example

Unit Price	\$1.00	\$2.20	\$11.00
Quantity	1	2	4
Depts.	1	2	3
Amount Tendered	\$50.00		

5 0 0 0 0

01	• 1•00		Unit Price
02	• 2•20	TX 1	Unit Price
02	• 2•20	TX 1	Repeat
	4	X	Multiplication Symbol
	• 11•00	@	Unit Price
03	• 44•00		
	• 4•40	TA	
	• 0•18	TX 1	
	• 49•58	ST	
	• 50•00	CA	Cash Amount Tendered
	• 0•42	CG	Change

Part-2

2-2 Single-Item Sales

(Programming: See page 18)

5 0

03	• 0•50		
	• 0•50	CA	Cash Sales

Example 1

Status	Single item sale
Unit Price	\$0.50
Quantity	1
Dept.	3

For this example, Dept. 1 is programmed for a single-item-sale. (Programming: See page 23.)

Example 2

Status	Normal	Single item sale
Unit Price	\$1.00	\$0.50
Quantity	1	1
Dept.	2	3

02	• 1•00	TX 1	
03	• 0•50		
	• 1•00	TA	Taxable Amount
	• 0•04	TX 1	Tax
	• 1•54	CA	Cash Sales

Single-item sale cannot be finalized if an item is registered previously.

Part-2 CONVENIENT OPERATION

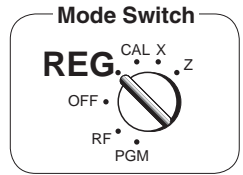

2-3 Check Sales



Example

Unit Price	\$35.00
Quantity	2
Depts.	4



04	•35.00	
04	•35.00	
	•70.00	CK — Check Sales

2-4 Change the Tax Status

Example

Unit Price	\$1.00	\$2.00
Quantity	1	1
Depts.	1	2
Preset Status	Non-Taxable	Taxable 1
This Registration	Taxable 1	Taxable 1

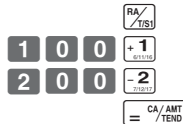

01	•1.00	TX 1
02	•2.00	TX 1
	•3.00	TA
	•0.12	TX 1
	•3.12	CA

2-5 Manual Tax

Example

Unit Price	\$1.00	\$2.00
Quantity	1	1
Depts.	1	2

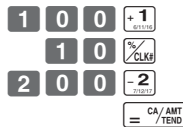

01	•1.00	
	•0.10	TX# — Manual Tax Symbol
02	•2.00	TX 1
	•2.00	TA
	•0.08	TX 1
	•3.18	CA

key is programmed to function as a Manual Tax key (see page 19).

2-6 PLU operation

(Programming: See page 23)

Example

PLU No.	1	2
Unit Price	\$1.00	\$2.00
Quantity	2	4
Link Dept. No.	2	2
Cash Amount tendered	\$10.40	

1 **PLU**

4 **PLU**

2 **PLU**

4 **X / FROM / DATE / END**

= **CA / AMT / TEND**

001	• 1•00	TX 1	PLU No.
001	• 1•00	TX 1	Repeat
	4	X	Multiplication Symbol
	• 2•00	@	Preset Unit Price
002	• 8•00	TX 1	
	• 10•00	TA	
	• 0•40	TX 1	
	• 10•40	CA	Cash Amount Tendered

2-7 PLU Single-Item Sale

(Programming: See page 22)

Example

PLU No.	1
Status	Single item sale
Unit Price	\$1.00
Quantity	1

1 **PLU**

001	• 1•00	TX 1	PLU No.
	• 1•00	TA	Taxable Status Symbol
	• 0•04	TX 1	Taxable Amount
	• 1•04	CA	Tax

- For this example, linked department 1 is programmed for a single-item-sale.
- Single-item sale cannot be finalized if an item is registered previously.

2-8 Split cash/ check sales

Example

Unit Price	\$30.00	\$25.00
Quantity	1	1
Depts.	2	3
Cash Amount tendered	\$20.00	
Check	\$36.20	

3 0 0 0 **- 2** **71011**

2 5 0 0 **x 3** **81013**

SUB TOTAL

2 0 0 0 **=** **CA / AMT / TEND**

CHK / NS

02	• 30•00	TX 1
03	• 25•00	
	• 30•00	TA
	• 1•20	TX 1
	• 56•20	ST
	• 20•00	CA
	• 36•20	CK

Part-2 CONVENIENT OPERATION

Mode Switch

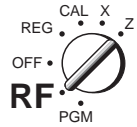

2-9 Refund

Operation

Printout

Example

Unit Price	\$1.00	\$2.00
Quantity	1	1
Depts.	2	3



13-55	0040	RF	Refund Mode Symbol
02	•1•00	TX 1	
03	•2•00		
	•1•00	TA	
	•0•04	TX 1	
	•3•04	CA	

After you finish RF mode operation, be sure to return the Mode Switch to the REG (register) setting.

2-10 Cashier Assignment

(Programming: See page 20)

Mode Switch

In any mode
REG, RF, CAL,
X or Z,
except PGM

Cashier assignment system is used to control each cashier (or clerk) sales total. When you select this function on page 20, you can get 8 cashiers (or clerk) sales data.

Cashier assignment must be performed prior to starting registration or any other operation, except Program mode.

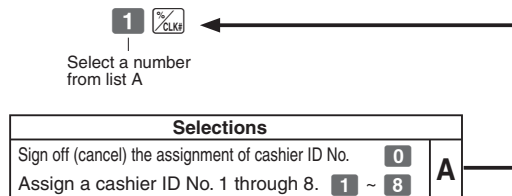

- Currently assigned cashier (or clerk) ID number is printed on the receipt or journal for each transaction.
- The assigned clerk memory number is automatically signed off when the mode key is set to OFF position.
- The assigned cashier (or clerk) sales totals with ID number are printed on the receipt or journal when you perform daily X/Z sales report.

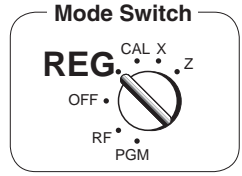

2-11 Other registrations

2-11-1 Reading the Time and Date

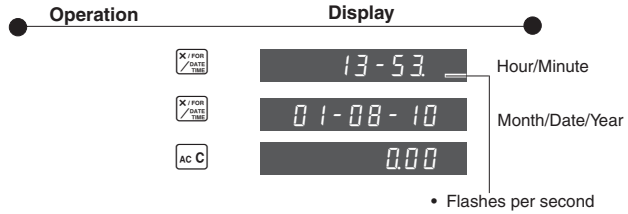

Part-2

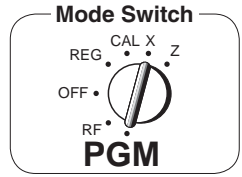

Adjusting the Time



Example

Current time = 13:58

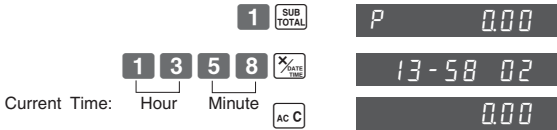

• Enter current time in 24 hour system.

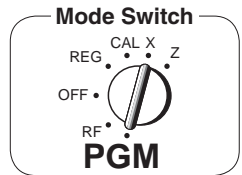

Adjusting the Date



Example

Current date = January 8, 2010

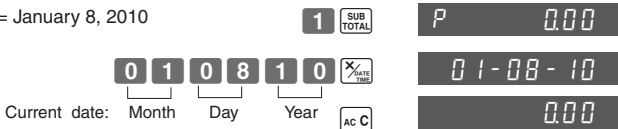

• Enter current date in 6 digits.
• Enter the last 2 digits for year set. (2010 → 10)

Part-2 CONVENIENT OPERATION

Mode Switch



2-11-2 Paid out from cash in drawer

Operation	Printout									
<p>1 2 3 4</p> <p>5 6 7 8 </p> <p>Enter reference No.</p> <p>1 0 0 0 </p>	<table border="1"> <tr> <td>12345678</td> <td>#</td> <td>Reference Number</td> </tr> <tr> <td>13-57 0041</td> <td></td> <td></td> </tr> <tr> <td>•10.00</td> <td>PO</td> <td>Paid Out Amount</td> </tr> </table>	12345678	#	Reference Number	13-57 0041			•10.00	PO	Paid Out Amount
12345678	#	Reference Number								
13-57 0041										
•10.00	PO	Paid Out Amount								

2-11-3 Cash received on account

Operation	Printout			
<p>6 0 0 0 </p>	<table border="1"> <tr> <td>•6.00</td> <td>RA</td> <td>Received On Account Amount</td> </tr> </table>	•6.00	RA	Received On Account Amount
•6.00	RA	Received On Account Amount		

2-11-4 Registering identification numbers

A reference number or ID number of up to 8 digits can be registered prior to any transaction.

Operation	Printout																		
<p>1 2 3 4</p> <p>5 6 7 8 </p> <p>5 0 </p> <p></p>	<table border="1"> <tr> <td>12345678</td> <td>#</td> <td>Reference No. or ID No.</td> </tr> <tr> <td>13-59 0046</td> <td></td> <td></td> </tr> <tr> <td>02</td> <td>•0.50</td> <td>TX 1</td> </tr> <tr> <td></td> <td>•0.50</td> <td>TA</td> </tr> <tr> <td></td> <td>•0.02</td> <td>TX 1</td> </tr> <tr> <td></td> <td>•0.52</td> <td>CA</td> </tr> </table>	12345678	#	Reference No. or ID No.	13-59 0046			02	•0.50	TX 1		•0.50	TA		•0.02	TX 1		•0.52	CA
12345678	#	Reference No. or ID No.																	
13-59 0046																			
02	•0.50	TX 1																	
	•0.50	TA																	
	•0.02	TX 1																	
	•0.52	CA																	

2-11-5 Reduction on subtotal

Example
Amount due reduced by \$0.50.

Operation	Printout																					
<p>1 0 0 </p> <p>2 0 0 </p> <p></p> <p>5 0 </p>	<table border="1"> <tr> <td>02</td> <td>•1.00</td> <td>TX 1</td> </tr> <tr> <td>02</td> <td>•2.00</td> <td>TX 1</td> </tr> <tr> <td></td> <td>•3.12</td> <td>ST</td> </tr> <tr> <td></td> <td>-0.50</td> <td></td> </tr> <tr> <td></td> <td>•3.00</td> <td>TA</td> </tr> <tr> <td></td> <td>•0.12</td> <td>TX 1</td> </tr> <tr> <td></td> <td>•2.62</td> <td>CA</td> </tr> </table> <p>See page 21 to print the subtotal line.</p>	02	•1.00	TX 1	02	•2.00	TX 1		•3.12	ST		-0.50			•3.00	TA		•0.12	TX 1		•2.62	CA
02	•1.00	TX 1																				
02	•2.00	TX 1																				
	•3.12	ST																				
	-0.50																					
	•3.00	TA																				
	•0.12	TX 1																				
	•2.62	CA																				

2-11-6 Premium/ Discount

•2.5% premium/discount (programmed to $\frac{\%}{\text{CAL}}$ key) applied to first item.

1 0 0 $\frac{+1}{\text{CAL}}$
 $\frac{\%}{\text{CLK}}$
 2 0 0 $\frac{-2}{\text{CAL}}$
 3 0 0 $\frac{+1}{\text{CAL}}$
 $\frac{\%}{\text{SUB TOTAL}}$
 7 $\frac{\%}{\text{CLK}}$
 $\frac{=}{\text{CA/AMT /TEND}}$

•Be sure to use $\frac{\text{SUB TOTAL}}{\text{CAL}}$ key when you wish to apply a premium/ discounting to the subtotal.

•7% premium/discount applied to transaction total.

•For programming the $\frac{\%}{\text{CAL}}$ key as percent minus or percent plus, see page 19.

•For programming percent rate, see page 17.

Premium	
01	•1•00
	2•5 % *1
	•0•03 *2
02	•2•00 TX 1
01	•3•00
	•6•03 ST *3
	7 % *4
	•0•42 TX 1 *5
	•2•14 TA
	•0•09 TX 1
	•6•54 CA

Discount	
01	•1•00
	2•5 % *1
	-0•03 *2
02	•2•00 TX 1
01	•3•00
	•5•97 ST *3
	7 % *4
	-0•42 TX 1 *5
	•1•86 TA
	•0•07 TX 1
	•5•62 CA

- *1 Premium/ Discount Rate
- *2 Premium/ Discount Amount
- *3 Subtotal
- *4 Premium/ Discount Rate
- *5 Premium/ Discount Amount

2-12 PLU report

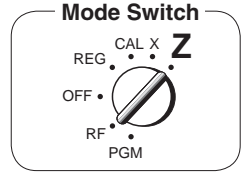
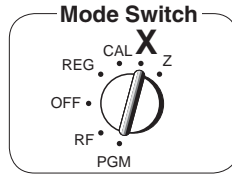

Operation

Printout

Mode Switch to **X** (Read)

0 1 $\frac{=}{\text{CA/AMT /TEND}}$

01-08-10	
19-35 0073	
01 0001	Z
001 12	Report code/Reset Counter
•12•00	PLU No./No. of items
000 27	Amount
100	
•180•00	
1284	PLU total count
•10856•89	PLU total amount

Mode Switch to **Z** (Reset)

0 1 $\frac{=}{\text{CA/AMT /TEND}}$

Part-2

Part 3

CALCULATOR FUNCTION

1. Calculator Mode

While registering at REG mode, you can switch to CAL mode and then return to REG mode to resume the registration.

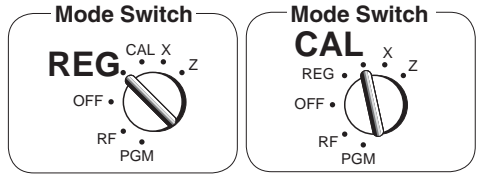

1-1 Calculation examples

● Operation	● Display ●
<p>AC c</p> <p>5 +¹ 1 AC c</p> <p>(Cancels item entered.)</p>	<p>[C] 0.</p>
<p>5+3-2=</p> <p>(23-56)×78=</p> <p>(4×3-6)÷3.5+8=</p> <p>12% on 1500</p>	<p>6.</p> <p>-2574</p> <p>97142857</p> <p>180.</p>

1-2 Memory recall

Recalls the current amount onto the display.

- during registration: current subtotal
- registration has been completed: the last amount

On REG mode

● Operation	● Display ●
<p>1 0 00 +¹ 2 0 00 +¹</p>	<p>[C] 10.</p>

On CAL mode

Example
Divide the current subtotal \$30.00 at REG mode by 3 (to divide the bill between 3 people).

<p>PLU ÷¹ 3 = CA/AMT/TEND</p> <p>Memory recall</p>	<p>Recalls the current result by pressing [= CA/AMT/TEND] key at CAL mode on the display.</p>
---	---

On REG mode

Example
Recall the current result at CAL mode during registration, and register the cash amount due for each person.

● Operation	● Printout ●
<p>PLU = CA/AMT/TEND</p> <p>PLU = CA/AMT/TEND</p> <p>PLU = CA/AMT/TEND</p> <p>Memory recall</p>	<p>01 •10•00</p> <p>01 •20•00</p> <p>•30•00 ST</p> <p>•10•00 CA</p> <p>•10•00 CA</p> <p>•10•00 CA</p> <p>•0•00 CG</p>

1-3 Setting for calculator operation

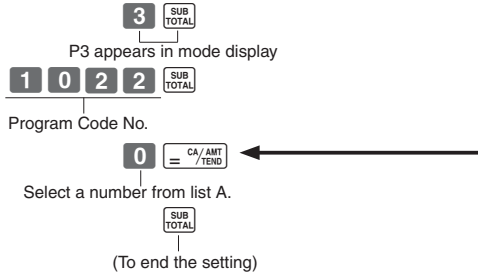
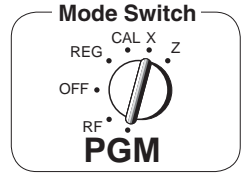

Selections			
Open drawer whenever = CA/AMT /TEND is pressed.*			
Open drawer whenever CHK /INS is pressed.*			
Print No. of Equal key operations on General Control X and Z reports.			
Yes	No	No	0
	Yes	Yes	1
	Yes	No	2
		Yes	3
No	No	No	4
	Yes	Yes	5
	Yes	No	6
		Yes	7

A

*Drawer does not open during registration procedures even if you press = CA/AMT
/TEND or CHK
/INS by turning the mode switch to CAL position.

Part-3



USEFUL INFORMATION

1. Troubleshooting

	Symptom/Problem	Most common causes	Solutions
1	E01 appears on the display.	Changing modes without completing transaction.	Return mode switch to where it stops buzzing and press [= $\frac{CH/AMT}{TEND}$].
2	E08 appears on the display.	Sign on operation is not performed.	Prior to starting registration of any other operation, press 1 ~ 8 and then $\frac{SIGN}{OK}$.
3	E94 appears on the display.	Printer paper is jammed.	Remove jammed paper. Turn Mode switch to OFF then turn to ON, or Turn power OFF and then turn power ON.
4	No date on receipt. Paper is not advancing enough.	Printer is programmed as a journal.	Program printer to print receipts.
5	Drawer opens up after ringing up only one time.	Department is programmed as a single item dept.	Program the dept. as a normal dept.
6	Not clearing totals at end of day after taking report.	Using X mode to take out reports.	Use Z mode to take out reports.
7	Programming is lost whenever register is unplugged or there is a power outage.	Bad or no batteries.	Put in new batteries and program again.
8	Register is inoperative. Can't get money out of drawer.	No power.	Pull lever underneath register at rear.

Note: If you cannot resolve your difficulty, please feel free to call your dealer or 1-800-638-9228.

2. Specifications

INPUT METHOD

Entry: 10-key system; Buffer memory 8 keys (2-key roll over)
 Display (LED): Amount 8 digits (zero suppression); Department/PLU No.; No. of repeats

PRINTER

Journal: 14 digits (Amount 10 digits, Symbol 3 digits)
 (or Receipt) Automatic paper roll winding (journal)
 Paper roll: 58 mm × 80 mm Ø (Max.)

CALCULATIONS

Entry 8 digits; Registration 7 digits; Total 8 digits

CALCULATOR FUNCTION

8 digits; Arithmetic calculations; Percent calculations

Memory protection batteries:

The effective service life of the memory protection batteries 3 (UM-3, or R6P (SUM-3) type batteries) is approximately one year from installation into the machine.

Power source/Power consumption: See the rating plate.

Operating temperature: 32°F to 104°F (0°C to 40°C)

Humidity: 10 to 90%

Dimensions: 7 ³/₈"(H)×13"(W)×14 ³/₁₆"(D) with S drawer
 (188 mm(H)×330 mm(W)×360 mm(D))

Weight: 9 lbs (4 kg) with S drawer

Specifications and design are subject to change without notice.

Tax Tables for USA

A

ALABAMA						ALASKA								ARIZONA	
4%	5%	6%	6%	6%	8%	KENAI 2%	3%	HOMER/ SELDOVIA	HAINES	JUNEAU	KENAI 5%	KENAI,SEWARD & SOLDOTNA	6%	4%	5%
			(4+1+1)					3%	4%	4%				5%	6%
0	0	0	0	0	0	0	0	0	0	0	0	0	6	0	0
1	1	1	1	1	1	1	1	1	1	1	1	1	159	1	1
1	1	1	1	1	1	1	1	1	1	1	1	1	179	1	5
10	10	8	9	10	7	6	1	1	1	1	1	1	199	2	10
30	29	24	20	20	21	18	1	4	4	2	1	1	219	29	27
54	49	41	40	36	35	31	25	34	25	19	12	13	219	29	47
73	69	58	55	54	49	43	75	49	34	37	37	25	239	49	68
110	89		70	70	64	56		83	75	62		46	259	69	89
	110		90	85	78	68		116	127			75	259	89	109
			109	110	92	81		150	155			79	279	109	
					107	93		183	177			118	300	129	
						106		216	227			127		159	
												151			

C

ARIZONA						ARKANSAS							CALIFORNIA				
6%	6.5%	6.7%	6.8%	7%		3%	4%	5%	6%	6.8%	7%	7.5%	6%	6.25%	6.5%	6.75%	
0	175	0	161	0	156	6.8	0	0	0	0	0	0	0	0	0	0	0
1	191	1	176	1	171	5002	1	1	1	1	1	1	1	1	1	1	1
9		7	192	7	186		14	12	10	8	6	7	6	7	7	7	6.75
10		7	207	7	201		44	37	20	24	19	21	19	10	10	10	5002
22		23	223	22	216		74		40	41	33	35	33	7	7	161	0
39		38	238	37	231		114		60	58	46	49	46	10	10	176	10
56		53	253	52	246				80			64		22	21	192	20
73		69	269	67	261				110			78		39	37	207	34
90		84	284	82	276							92		56	54	223	48
107		99	299	97	291							107		73	70	238	64
125		115		111		107								90	86	253	80
141		130		126										108	103	269	96
158		146		141										124	119	284	111

CALIFORNIA										COLORADO							
7%	7.25%	7.25%	7.5%	7.75%	8.25%	8.5%	LOS ANGELES 10% PARKING	1.5%	2%	2.5%	3%	3.5%	3.6%	3.85%	4%		
0	121	278	7.25	117	7.25	0	7.75	8.25	0	99	0	99	0	0	0	0	
1	135	292	5002	131	5002	1	5002	5002	1	111	1	99	1	1	1	291	
8	149	307	0			3			1	123	11	104	3	2	5	319	
10	164		10			6			5	135	99	114	17	17	17	347	
20	178		20			19			17	147	99	124	49	42	41	375	
33	192		32			33			29	158	99	134	83	71	69	63	
47	207		46			46			41	170	99	144	116	99	97	16	
62	221		60			59			52	182	99	154	149	128	124	37	
76	235		74			73			64	194	99		183	157	152	63	
91	249		88						76	205	99			185	180	17	
107	267		103						88		99			214	208	2	
														242	236	2	

Part 4

E

Tax Tables

COLORADO

		LOVELAND																				
4.5%	5%	5%	5.25%	5.5%	5.6%	5.75%	6%	6.1%	6.35%	6.4%	6.45%	6.5%	6.6%	7%	7.01%	7.1%						
0	211	0	0	5.25	0	172	0	168	0	165	0	6.1	6.35	6.4	6.45	0	146	6.6	0	135	7.01	7.1
1	233	1	1	5002	1	190	1	186	1	182	1	5002	5002	5002	5002	1	161	5002	1	149	5002	5002
5	255	2	1		6	209	7	204	8	199	2	0			0	2	176		4		17	
17	277	17	18		17	227	16	222	17	217	17	17			17	17	192		17		21	
33	299	29	18		27	245	25	240	26	24	24				23	207		21		35		
55		49	51		45	263	43		43	41	41				38	223		35		49		
77			68		63	281	61		60	58	58				53			49		64		
99			84		81	299	79		78	74	74				69			64				
122			118		99		97		95						84			78				
144					118		115		113						99			92				
166					136		132		130						115			107				
188					154		150		147						130			121				

D

F

COLORADO

7.2%	7.25%	7.3%	7.5%	8%
0	131	0	0	0
1	145	7.25	1	1
2	159	3	157	3
17	173	6	171	6
20	187	20	19	18
34	201	34	33	31
48	215	47	46	43
62	229	61	59	56
76	243	75	73	68
90	256	89	81	141
104		102	93	160
118		116	106	179

CONNECTICUT

5.25%	6%	7%	7.5%	8%
0	198	0	0	0
1	218	1	1	1
2		2	1	3
		8	7	6
16		24	21	19
27		41	35	33
46		58	49	46
65		74	64	56
84		91	78	73
103		108	92	
122		124	107	
141				
160				
179				

DISTRICT OF COLUMBIA

D.C. 5%	D.C. 5.75%	D.C. 6%	D.C. 6%	D.C. 8%	D.C. 9%
0	5.75	0	0	0	0
1	5002	1	1	1	1
1	0	1	1	1	6
10	8	12	8	12	6
22		17	24	16	16
42		35	41	27	27
62		53	58	39	38
82		71	74	50	49
110		89	91	62	61
		112	108	75	72
				90	83
				112	94

FLORIDA

4%	5%	5.25%
0	175	0
1	209	1
5		1
9		9
25		20
40		40
75		60
109		80
125		109
150		

G

H

I

FLORIDA

		PANAMA CITY BEACH			
6%	6.2%	6.5%	7%	7.5%	
0	6.2	0	107	0	93
1	5002	1	123	1	106
1		1	138	1	120
9		9	153	9	133
16		15	169	14	146
33		30	184	28	160
50		46	209	42	173
66		61		57	186
83		76		71	209
109		92		85	80

GEORGIA

3%	4%	5%	6%	7%
0	0	0	0	0
1	1	1	1	1
1	1	1	1	1
10	10	10	10	7
35	25	20	20	21
66	50	40	35	35
110	75	60	50	49
	110	80	67	64
		110	85	78
			110	92
				107

HAWAII

4%
0
1
1
12
37

IDAHO

3%	4%	4.5%	5%	6%
0	0	0	0	0
1	1	1	1	1
1	2	2	2	2
15	11	15	11	11
42	32	27	25	20
72	57	49	45	37
115		71		53
		93		70
		115		87
		137		103
		160		120
		183		137
		205		153

E

ILLINOIS												INDIANA						IOWA		
1%	1.25%	2%	5%	6%	6.25%	6.5%	6.75%	7%	7.5%	7.75%	8%	8.75%	1%	4%	5%	MARION County	RESTAURANT	7%	4%	5%
0	0	0	0	0	0	161	6.75	0	0	7.75	0	8.75	1%	4%	5%	5%	6%	7%	0	0
1	1	1	1	1	1	176	5002	1	1	5002	1	5002	0	0	0	0	0	0	1	1
1	1	1	6	1	1	192		1	1	0	1	0	0	0	0	0	0	121	3	1
49	39	24	12	8	7	207		8	6	6	6	5	1	1	1	1	1	135	12	9
148	119	74	25	24	23	23		22	19				1	2	1	1	1	149	37	29
			46	41		38		36	33				49	15	9	15	9	164	50	
			67	58		53		50	46				148	37	29	37	29	178	75	
			88			69		65						62		49	49	193		
			109			84		79								62	49			
			129			99		93								87	69	64		
						115		108								112	89	78		
						130										137	109	92		
						146											107			

K

KANSAS																			
IOWA	2.5%	3%	3.1%	3.25%	3.5%	3.75%	4%	4.1%	4.5%	5%	5.25%	5.5%	5.65%	5.9%	6%	6.15%	6.4%	6.5%	9.5%
0																			
1	0	0	3.1	323	0	279	0	4.1	0	0	5.25	0	190	5.65	5.9	0	6.15	6.4	6.5
1	1	1	5002	1	353	1	1	306	1	1	5002	1	209	5002	5002	1	5002	5002	1
8	1	1	0	1	384	1	1	333	1	0	1	1	1	0	7	0	0	0	1
24	19	16	16	15	415	14	13	359	12	12	11	9	9	8	8	8	7	7	5
41	59	49		46		42	39	386	37		33	29	27			24			15
58	99	83		76		71	66	413	62		55		45			41			26
74	139	116		107		99	93		87		77		63			58			36
91	179			138		128	119		112		99		81			74			47
108				169		157	146				122		99			91			57
				199		185	173				144		118			108			68
				230		199					166		136			124			78
				261		226					188		154			141			89
				292		253					211		172			158			99

Part 4

L

KANSAS		KENTUCKY		LOUISIANA									
10%	5%	6%	2%	3%	4%	4.5%	5%	6%	6%	7%	7.5%	8%	9%
0	0	0	0	0	0	0	0	0	161	0	0	0	0
1	6	2	1	1	1	1	1	1	176	1	1	1	1
1	10	8	2	2	2	1	6	2	17	192	1	2	7
4	25	24	24	16	12	11	10	8	7	207	7	6	4
14	46	41	74	49	37	33	27	24	23	223	21	19	16
24	67	58	124	82	62	55	47	41	38	238	35	33	29
34	88	74	174	116	87	77	67	58	53	253	49	46	42
44	109		224	149	112	99	87	74	69	269	64	59	55
54	129					122	109		84	284			67
64						144	129		99	299			80
74						166			115	315			93
84						188			130	330			106
94						211			146				105

M

MAINE			MARYLAND			
5%	6%	7%	4%	5%	5%	6%
0	0	7	0	0	0	0
1	1	2	0	1	1	1
1	1	0	1	1	1	1
10	9	7	2	2	7	3
20	16	21	24	19	99	19
40	33	35	25	20	99	20
60	50	49	50	40	99	33
80	66	64			99	50
110	83	78			99	66
	109	92			100	83
		100			120	100
					140	116

Tax Tables

MASSACHUSETTS			MICHIGAN		MINNESOTA				MISSISSIPPI						MISSOURI						
4.625%	5%		4%	6%	6%	6.5%	7%	8.5%	5%	6%	7%	8%	8.5%	9%	9.25%	4.225%	4.6%	4.625%			
0	227	0	0	0	0	0	161	0	0	123	0	0	0	0	0	123	0	9.25	0	0	227
1	248	1	1	2	1	1	176	1	1	135	1	1	1	1	1	135	1	5002	1	1	248
13	270	1	12	10	1	1	192	1	1	147	6	1	1	1	1	147	1	0	1	1	270
10	291	9	31	24	8	7	207	7	5	158	11	8	7	6	5	158	5	5	11	10	291
32	313	29	54	41	24	23	21	17	170	26	24	21	18	17	170	16		35	32	32	313
54	335		81	58	41	38	35	29	182	47	41	35	31	29	182	27		59	54	54	335
75	356		108	74	58	53	49	41	194	68	58	49	43	41	194	38		82	76	75	356
97	378		135	91	69	64	52	205	88	74	64	56	52	205	49			97	97	97	378
118	399		162	108	84	78	64			109	91	78	68	64		61				118	399
140	421		187	124	99	92	76			129	105	92	81	76		72				140	421
162	443				115	107	88					107	93	88		83				162	443
183					130		99						106	99		94				183	
205					146		111							111		105				205	

MISSOURI																								
4.725%	4.75%	4.8%	4.975%	5.05%	5.1%	5.225%	5.6%	5.625%	5.725%	6.1%	6.225%	6.3%	6.425%	6.475%	6.55%	6.725%	7.225%							
0	0	0	0	211	0	0	5.225	0	187	0	5.725	0	0	168	0	166	0	163	0	162	0	160	6.725	7.225
1	1	1	1		1	1	5002	1	205	1	5002	1	1	184	1	182	1	178	1	177	1	175	5002	5002
4	3	3	1		5	1		15	223	1		1	2	200	8	198	1	194	13	193	9	190		
10	10	10	10		9	9		8	241	8		8	8	216	7	214	7	210	7	208	7			
31	22	31	30		19	29		26	258	26		24	24	232	23	230	23	225	23	223	22			
52	43	52	50		39	49		44	276	44		40	40	248	39	246	38	241	38	239	38			
74	65	72	70		59	68		62	294	62		57	56	265	55	263	54	256	54	254	53			
95	86	93	90		79	88		80	312	79		73	72		71	70	272	69	270	68				
116	107	114	110		98	107		98	330	97		90	88		87	85	287	84	285	83				
137	128	135	130		118			115	348	115			104		103	101		100	301	99				
158	149	156	150		138			133	366	133			120		119	116		115	316	114				
179	170	177	170		158			151	383	151			136		134	132		131	332	129				
201			190		178			160		168			152		150	147		146		145				

NEBRASKA									NEVADA												
3%	3.5%	4%	4.5%	5%	5.5%	6%	6.5%		3%	3.5%	5.75%	6%	6.25%	6.5%	6.75%	7%					
0	0	0	0	233	0	0	190	0	0	161	0	0	299	0	167	0	161	6.75	0		
1	1	1	1	255	1	1	209	1	1	176	1	1	326	5002	1	1	183	1	176	5002	1
3	3	2	6	277	2	2	227	1	1	192	2	6	357		2	2	199	1	192	0	1
16	14	14	14	299	14	14		8	7	207	14	14			8	7	215	7	207	7	7
49	42	37	33	322	29	27		24	23		49	38			24	23			22	21	
83	71	62	55		49	45		41	38		83	64			41	39			38	37	35
116	99		77		63			58	53		116	88			58	55			53		49
149	128		99		81				69		149	118			74	71			69		64
183	157		122		99				84			157				87			84		78
	185		144		118				99			185				103			99		92
	214		166		136				115			214				119			115		107
	242		188		154				130			242				135			130		
	271		211		172				146			271				151			146		

NEW HAMPSHIRE			NEW JERSEY				NEW MEXICO												
7%	Rooms & Meals 7%	Rooms & Meals 8%	3%	3.5%	6%	7%	3.75%	4.25%	4.375%	4.5%	4.875%	5.175%	5.25%	5.375%	5.75%				
0	129	0	0	0	0	150	0	280	0	247	0	239	0	4.875	5.175	0	199	5.375	5.75
1	143	1	1	1	1	164	1	306	1	270	1	1	1	5002	5002	1	217	5002	5002
8	158	8	17	14	10	10	13	359	11	317	11	11	11			9			
14	172	35	41	42	22	21	40		35	341	34	33	33			28			
26	186	35	71	71	38	35	67		58	364	57	55	55			47			
39	201	38	117	100	56	50	93		82	388	79	78	78			66			
51		50		128	72	64	120		105	411	102	100	100			85			
63		62		157	88	78	146		129		125	122	122			104			
75		74		185	110	92	173		152		148	144	144			123			
88		87		214		107	200		176		171	167	167			142			
101		100				121	226		199		194	189	189			161			
115		114				135	253		223		217	211	211			180			

NEW MEXICO			NEW YORK													SUFFOLK County							
5.75%	6.187%	6.1875%	4%	5%	5.25%	5.75%	6%	6.25%	6.5%	6.75%	7%	7.25%	7.5%	8%	8.25%	8.5%							
5.75	0	6.187	0	0	5.25	5.75	0	141	0	0	130	6.75	0	121	7.25	0	113	0	105	0	106	8.25	8.5
5002	1	5002	4	0			1	158	1	1	146	5002	1	135	5002	1	126	1	119	1	118	5002	5002
	4	0	1	1	5002	5002	1	7	7	1	161		8	149		8	139	10	131	9	131		
	9	8	5	6			7	10	10	7	176		10	164		10	10	10	144	10			
	23		12	10			10	22	22	23	192		20	178		18	17	17		17			
	40		33	27			22	38	38	38	207		33	192		31	29	29		29			
	56		58	47			56	54	53				47	207		45	42	42		42			
	72		83	67			72	70	69				62			58	55	54		54			
	88		112	87			88	86	84				76			71	67	67		67			
	104		137	109			108	103	99				91			85	80	79		79			
	120			129			124	119	115				107			99	92	92		92			
	136																						
	153																						

Part 4

NORTH CAROLINA							NORTH DAKOTA								OHIO				
3%	4%	4.5%	5%	CHEROKEE Reservations	6%	6.5%	3%	4%	4%	5%	5.5%	6%	6.5%	7%	8%	5%	5.5%	5.75%	
0	0	0	188	0	0	0	0	0	0	0	182	0	0	170	0	0			
1	1	1	211	1	1	1	1	1	1	1	200	1	1	185	1	1	0	0	146
3	5	2	233	6	2	2	2	2	2	2	219	3	2	200	2	3	0	1	164
15	15	15					15	15	15	15		15	15	216	15	15	2	2	182
33	31	25					20	19	17	31		17	31	231	15	15	2	2	200
67	51	50					40	37	34	47		34	47		29	25	15	15	200
100	71	75					55	50	62	77		50	62		43	38	20	18	218
133	100	100					73	67	77	58		67	77		58	50	40	36	
166	125	125					91	84	93	72		84	93		72	63		54	
200							110		108	86			108		86	75		72	
							128		124	100			124		100	88		90	
							146		139	115			139		115	100		109	
							164		154				154					127	

Tax Tables

OHIO										OKLAHOMA											
MEIGS Co.								CUYAHOGA Co.				2%	3%	3.25%	4%	4.25%	4.5%	5%	5.25%	6%	6.25%
6%	6%	6.25%	6.5%	6.75%	7%	7%	7%	7.35%	7.75%												
0	0	134	0	0	123	0	118	0	115	0	115	0	0	323	0	4.25	0	0	5.25	0	0
1	1		1	1	138	1	133	1	128	1	128	1	1	353	1	5002	1	1	5002	1	1
2	3		2	3	153	3	148	3		3		3	3	384	1		2	1		1	1
15	16		15	15	169	15	162	15		15		15	15	415	12		11	9		8	7
17	17		16	15	184	15	177	15		15		15	15	446	37		33	29		24	23
34	34		32	30	200	29	192	28		28		27	27	476			55			41	
50	50		46	46	215	44		42		42		41	41	507			77			58	
67	67		61	61	230	59		57		57		55	55	538			99				
83	83		76	76	74	71		71		71		68	68	569			121				
100	100		92	92	88	85		85		85		82	82	599			144				
117	117		107	107	103	100		100		100		96	96	291							

OKLAHOMA							P PENNSYLVANIA		R RHODE ISLAND		S SOUTH CAROLINA			SOUTH DAKOTA				
6.725%	7%	7.25%	7.375%	8%	8.25%	9.25%	6%	7%	6%	7%	4%	5%	CHARESTON	4%	5%	5.5%	6%	
6.725	0	7.25	7.375	0	0	0	0	0	0	149	0	0	0	0	0	0	0	0
5002	1	5002	5002	1	1	1	1	1	1	164	1	1	1	1	1	1	1	1
	6		0	1	1	4	1	1	5	167	6	5	178	5	6	2	1	1
	8		6	6	6	5	4	4	10	184	9	7	192	10	10	10	12	10
	22		18	18	16	14	14	14	17	210	26	21	207	25	20	24	37	30
	37		31	30	27	24	24	24	34	217	42	35	221	50	40	41		
	51			42	37	34	34	34	50	234	57	49	235	75	60	41		
	65			54	48	43	43	43	67	250	73	64	249	112	80	58		
	79			66	59				84	250	90	78	264	137	109	74		
	94			78	70				110	84	106	92			129	91		
	108			90	81				110	110	123	107			108	108		
	122			103	91				117	117	140	121			124	124		
									134			135						

SOUTH DAKOTA		TENNESSEE																
6.5%	7%	4.5%		5.5%			6%	6.25%	6.5%	6.75%	7%	COUNTY TAX		7.5%	7.75%	8%	8%	8.25%
0	161	0	188	0	154	354	0	0	0	130	0	125	0	117	0	0	0	0
1	176	1	211	1	172	372	1	1	1	146	1	140	1	130	1	7.75	0	0
7	192	4		1	190	390	2	2	2	161	8	155	2	144	2	2	2	2
23	207	7		11	209		10	10	10	176	10	170	10	158	10	10	10	10
38		21		33	227		24	23	23	192	22	185	21	172	19	18	18	18
53		21		55	245		41	39	38	207	37	199	35	185	33	31	31	31
69		21		77	263		58	55	53	223	51	214	49	48	46	43	43	43
84		21		99	281		74	71	69		66	229	64	61	59			
99		21		122	299			87	84		81	244	78	75				
115		21		144	318				99		96	259	92	89				
130		21		166	336				115		111	274	107	103				
146		21																

TENNESSEE			TEXAS															
8.5%	8.75%		4%	4%	4.125%	4.625%	5%	5.125%	5.25%	5.375%	5.5%	5.625%	6%	DALLAS	HOUSTON (Harris County)	6.125%	6.25%	
0	99	8.75	0	0	0	181	4.625	0	142	5.375	0	137	0	133	0	0	0	0
1	111	5002	1	1	1	206	5002	1	161	5002	1	155	1	151	1	1	1	6.125
2	123		1	1	1	230		1	180		1	173	1	168	1	1	1	5002
10	135		12	12	12	254		9	199		9	191	8		8	9	8	1
17	147		37	37	36	278		29	209		27	209	26		24	25	24	7
29	158							49			47		44		41	42	41	23
41	170							69			66		63		58	59	58	39
52	182										85		81		79		74	55
64	194										104		99		97		91	71
76	205										123		118		115		108	87
88	217																	103

U

TEXAS								UTAH										
6.25%	6.75%	7%	7.25%	7.5%	7.75%	8%	8.25%	4.75%	5%	5.25%	5.375%	5.5%	5.75%	5.875%	6%	6.125%	6.25%	7%
0	221	0	0	199	0	0	190	5.75	5.875	0	6.125	0	0	0	6.125	6.25%	0	0
1	242	1	1	219	1	1	209	5002	5002	1	5002	1	1	1	1	5002	1	1
1	263	1	1	238	1	1	209			0	2	0	4	2	0	4	2	2
10	284	9	9	257	9	9				8	8	8	7	7	8	7	7	7
31	305	29	28	276	27	27				24	24	23	21	21	24	23	21	21
52	326		47	295	46	45				41	41	27	35	35	41	27	35	35
73	347		66	314	65	63				58	58	47	49	49	58	47	49	49
94	368		85	333	83	81				74	74	63	64	64	74	63	64	64
115	389		104	352	102	99						99	78	78				78
136	410		123	371	118	118						118	92	92				92
157			142	390	136	136						136	107	107				107
178			161	409	154	154						154						
199			180		172	172						172						

Part 4

V

UTAH		VERMONT					VIRGINIA									
7.25%		3%	4%	5%	6%	8%	ARLINGTON COUNTY		FAIRFAX		FAIRFAX CITY Meals tax	HAMPTON Restaurant	LEESBURG Meal tax	RICHMOND Restaurant		
7.25	5002	0	0	0	6	0	4%	4.5%	5%	5.5%	6.5%	7%	7%	7%		
1	1	1	1	1	5002	1	0	0	188	0	169	0	124	0		
4	2	2	10	0			1	1	211	1	1	1	134	1		
13	10	10	10	18			2	5	233	1	4	188	13	149		
33	25	20	16	31			12	15	255	9	11	211	11	174		
66	50	40	33	43			34	34	314	37	33	277	29	14		
100		80	50	56			62	55	299	49	33	249	33	211		
133		100	66	68			87	77		69	55	255	55			
166		120	83	81			112	99		89	77		74			
200		140	100	93			137	122		109	99		59			
			116	100				144		129	122		74			
			133					166		149	144		77			
			150								122		84			
											144		249			
											122		107			
											122		114			
													259			
														114		

Tax Tables

W

VIRGINIA																
ALEXANDRIA 7.5%	NEWPORT NEWS 7.5%	RICHMOND 7.5%	Restaurant 8%	ROANOKE CITY VA BEACH 8.5%	9%	NORFOLK CITY Meal tax 9%	CITY OF RICHMOND Food tax 9.5%	9.5%								
7.5	0	116	0	114	0	99	9	0	99	211	0	89	205	0	89	209
5002	1	122	1	114	1	112	5002	1	99	233	1	99		1	99	
	1	144	2	5	134	1	122	6	122	233	1	110		1	109	
	11	149	6	14	134	11	137	11	122		5	121		9	122	
	16	166	19	34	159	12	144	33	144		15	131		11	129	
	33	183	33	44		33	162	44	144		26	142		29	144	
	49	188	46	44		37	166	44	166		36	152		33	149	
	55	211	59	59		55	187	55	166		47	163		49	166	
	77		59	59		62	188	55	188		57	173		55	169	
	83		84	84		77	211	77	188		68	184		69	188	
	99		84	84		87		77	211		78	194		77	189	

WASHINGTON			
7%	7.2%	7.3%	
0	0	131	0
1	1		1
1	1		1
7	6		6
21	20		19
35	34		33
49	48		47
64	62		61
78	76		74
92	90		88
107	104		102
	118		115

WASHINGTON									
7.5%	7.55%	4.125%		7.8%	7.9%	8%	8.1%	Combined 8.1%	8.7%
0	126	0	0	124	282	7.8	0	0	117
1	139	1	1	138		2	1	1	129
1	153	2	3	151		0	2	1	141
6	166	7	6	164		7	6	6	154
19	179	19	19	177		19	18	18	166
33	193	33	32	190		32	31	31	179
46	206	46	46	203		44	44		191
59		59	59	217		57	56		203
73		72	72	230		70			67
86		85	85	243		83			80
99		98	98	256					92
113		111	111	269					104

WEST VIRGINIA					
2%	3%	4%	5%	6%	
0	0	0	0	0	
1	1	1	1	1	
2	2	1	2	2	
25	5	12	5	5	
50	35	37	20	16	
100	70		40	33	
	100			50	
	135			67	
				84	
				100	
				116	

WISCONSIN				
4%	5%	5.5%	5.6%	
0	0	0	190	0
1	1	1	209	1
1	1	1		1
12	10	9		8
37	21	27		26
	41	45		44
	61	63		62
	81	81		80
	110	99		98
		118		116
		136		133
		154		
		172		

WYOMING			
3%	4%	5%	6%
0	0	0	0
1	1	1	1
2	2	2	3
24	24	24	24
49	37	29	24
83	62	49	34
116		69	51
149		89	68
		109	84

► To replace the ink roll

- ① Turn to the OFF mode and remove the printer cover.
- ② Lift up the tab on the ink roll marked “PULL UP”.
- ③ Install a new Ink Roll and press it down firmly but gently until it snaps into place.
- ④ Replace the printer cover onto the cash register.
- ⑤ Turn to the REG mode and press the  key to check for correct operation.

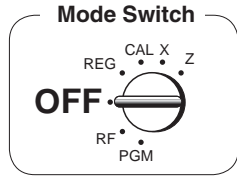

**GUIDELINES LAID DOWN BY FCC RULES FOR USE OF THE UNIT IN THE U.S.A.
(Not applicable to other areas)**

WARNING: This equipment has been tested and found to comply with the limits for a Class A digital device, pursuant to Part 15 of the FCC Rules. These limits are designed to provide reasonable protection against harmful interference when the equipment is operated in a commercial environment. This equipment generates, uses, and can radiate radio frequency energy and, if not installed and used in accordance with the instruction manual, may cause harmful interference to radio communications. Operation of this equipment in a residential area is likely to cause harmful interference in which case the user will be required to correct the interference at his own expense.

FCC WARNING: Changes or modifications not expressly approved by the party responsible for compliance could void the user's authority to operate the equipment.

LIMITED WARRANTY: ELECTRONIC CASH REGISTERS

This product, except the battery, is warranted by Casio to the original purchaser to be free from defects in material and workmanship under normal use for a period, from the date of purchase, of one year for parts and 90 days for labor. For one year, upon proof of purchase, the product will be repaired or replaced (with the same or a similar model) at Casio's option, at a Casio Authorized Service Center without charge for parts. Labor will be provided without charge for 90 days. The terminal resident software and programmable software, if any, included with this product or any programmable software which may be licensed by Casio or one of its authorized dealers, is warranted by Casio to the original licensee for a period of ninety (90) days from the date of license to conform substantially to published specifications and documentation provided it is used with the Casio hardware and software for which it is designed.

For a period of ninety (90) days, upon proof of license, Casio will, at its option, replace defective terminal resident software or programmable software, correct significant program errors, or refund the license fee for such software. Significant program errors will be significant deviations from written documentation or specifications. These are your sole remedies for any breach of warranty. In no event will Casio's liability exceed the license fee, if any, for such software. This warranty will not apply if the product has been misused, abused, or altered.

Without limiting the foregoing, battery leakage, bending of the unit, a broken display tube, and any cracks or breaks in the display will be presumed to have resulted from misuse or abuse. To obtain warranty service you must take or ship the product, freight prepaid, with a copy of the sales receipt or other proof of purchase and the date of purchase, to a Casio Authorized Service Center. Due to the possibility of damage or loss, it is recommended when shipping the product to a Casio Authorized Service Center that you package the product securely and ship it insured. CASIO HEREBY EXPRESSLY DISCLAIMS ALL OTHER WARRANTIES, EXPRESS OR IMPLIED, INCLUDING ANY IMPLIED WARRANTY OF MERCHANTABILITY OR OF FITNESS FOR A PARTICULAR PURPOSE. NO RESPONSIBILITY IS ASSUMED FOR ANY INCIDENTAL OR CONSEQUENTIAL DAMAGES, INCLUDING WITHOUT LIMITATION DAMAGES RESULTING FROM MATHEMATICAL INACCURACY OF THE PRODUCT OR LOSS OF STORED DATA. SOME STATES DO NOT ALLOW THE EXCLUSION OR LIMITATION OF INCIDENTAL OR CONSEQUENTIAL DAMAGES, SO THE ABOVE LIMITATIONS OR EXCLUSIONS MAY NOT APPLY TO YOU. This warranty gives you specific rights, and you may also have other rights which vary from state to state.

CASIO, INC.
570 MOUNT PLEASANT AVENUE,
P. O. BOX 7000, DOVER, NEW JERSEY 07801 U.S.A.

Model:.....Serial Number:..... Date of Purchase:.....

Your Name:.....

Address:.....

Dealer's Name:.....

Address:.....

CASIO®

CASIO COMPUTER CO., LTD.
6-2, Hon-machi 1-chome
Shibuya-ku, Tokyo 151-8543, Japan

PCR-272.INC
MA0812-A